

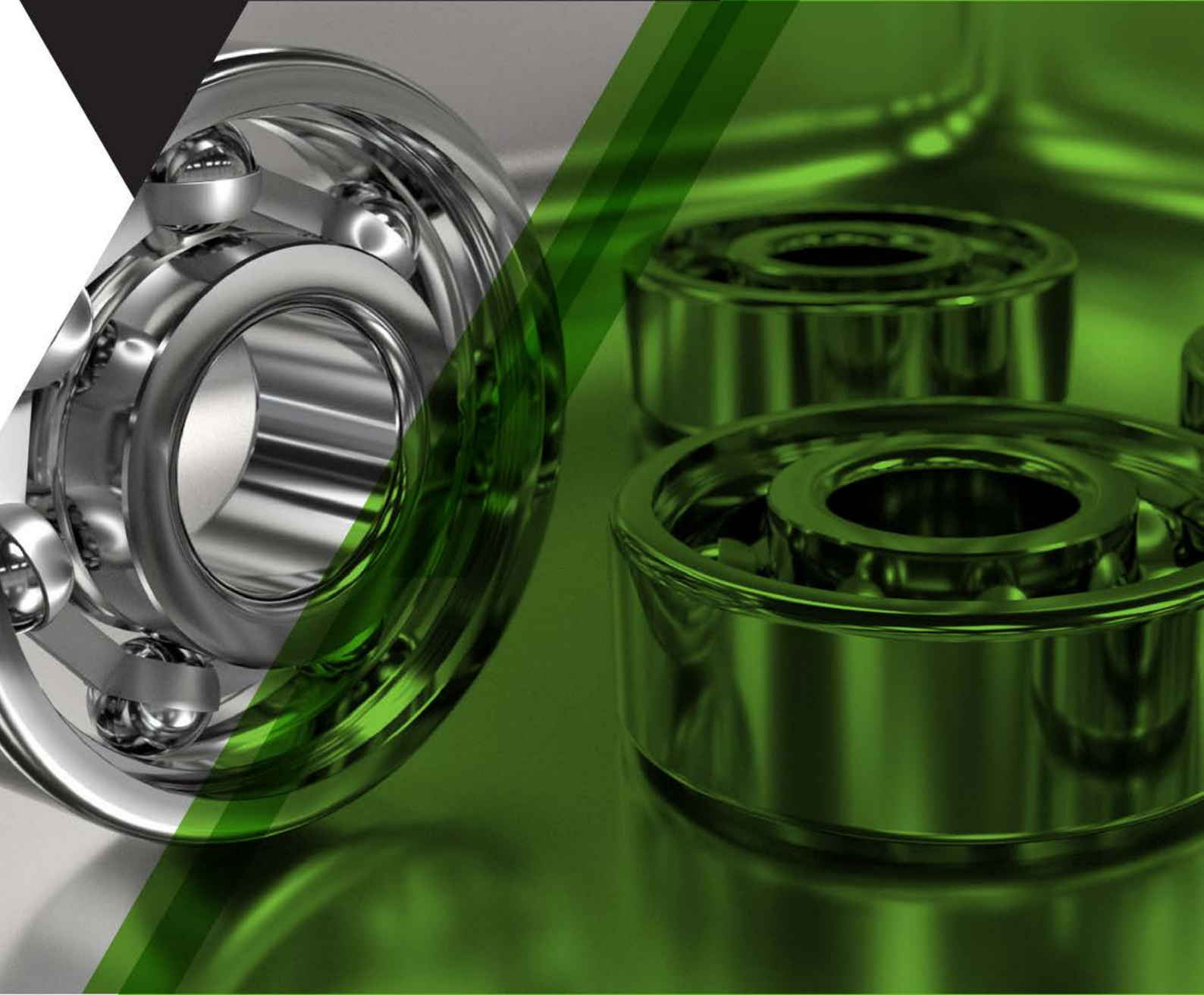

KANAMOZA PTY LTD
Industrial Suppliers



www.kanamoza.co.za

KANAMOZA INDUSTRIAL SUPPLIERS

MECHANICAL COMPONENTS CATALOGUE

Mechanical Components Solutions

Kanamoza supplies a wide range of industrial mechanical components designed to support operational efficiency, equipment reliability, and reduced downtime across demanding industrial environments. From power transmission systems and bearings to couplings, gear systems, pulleys, chains, and industrial hardware, we source quality components from trusted manufacturers to meet the operational requirements of various industries.

Whether your requirement is for maintenance, breakdown replacement, preventative servicing, or new installations, our team assists in sourcing the correct component specifications for your application.

Get A Quote

Provide the required component type, specifications, or application requirements to receive detailed product information and available configurations from trusted industrial suppliers.

Consultants are available to assist with selecting the correct mechanical component solution for your operational needs.

APPLICATIONS



MINING OPERATIONS



MANUFACTURING PLANTS



AGRICULTURAL EQUIPMENT



CONSTRUCTION MACHINERY



PROCESSING FACILITIES



INDUSTRIAL AUTOMATION

Contents

1. Bearings	3
2. Agricultural Products	5
3. Electric Motors & Power Transmission	8
4. Gearboxes and Geared Units	9
5. Couplings	9
6. Belts & Pulleys	10
7. Chains & Sprockets	11



ENERGY & UTILITIES



HEAVY ENGINEERING

BEARINGS

Industrial bearings engineered for smooth rotational movement, load handling, and equipment reliability across heavy-duty applications.

APPLICATIONS

- Electric motors
- Conveyor systems
- Pumps and compressors
- Gearboxes and drives
- Agricultural machinery
- Rotating industrial equipment
- Automated production systems

AVAILABLE INDUSTRIAL BEARING BRANDS & SYSTEMS

Link-Belt Bearings

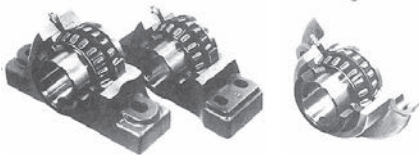

***Available in Fixed Type and Floating Type*

Dodge ISN Shaft Ready



Cooper Split Roller Bearings



RBC Bearings

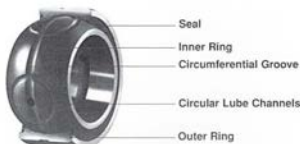

INA FAG Bearings



AVAILABLE TYPES

1. Outer Ring 2. Inner Ring 3. Rolling Elements 4. Cage

Ball Bearings

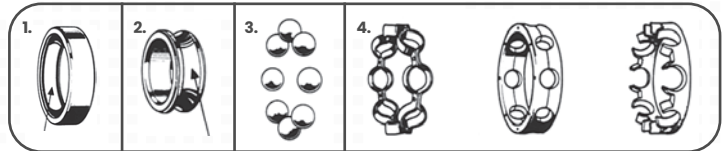

Tapered Roller Bearings

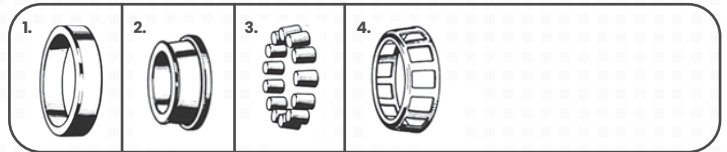

Needle Roller Bearings

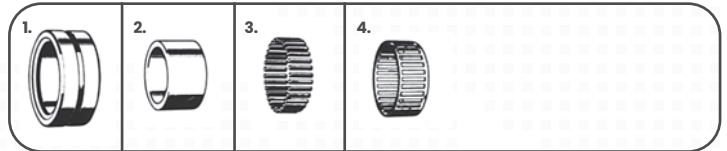

Cylindrical Roller Bearings

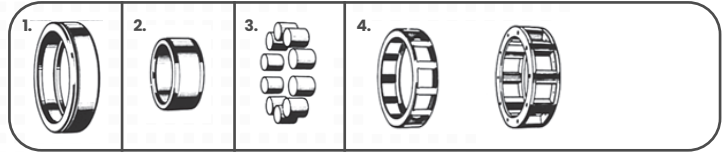

Self-Aligning Roller Bearings

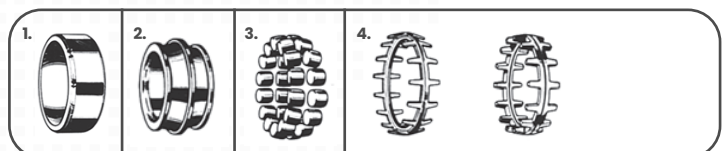

Supply available across trusted industrial bearing brands and mounted bearing systems suitable for fixed, floating, high-load, and continuous-duty applications.

Consult with Kanamoza for **bearing selection, sizing, housing configurations, load requirements, and replacement** support sourced from trusted industrial suppliers.

 sales@kanamoza.c.za  +27 62 754 0975

BEARINGS

AVAILABLE BEARINGS AND SERIES

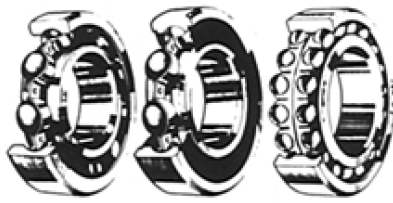

Single/double row deep groove ball bearings

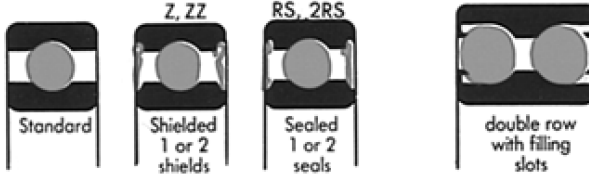

Single row SERIES	Double row SERIES
600	4200
16000	4300
620	
6000	
630	
6200	
6300	
6400	

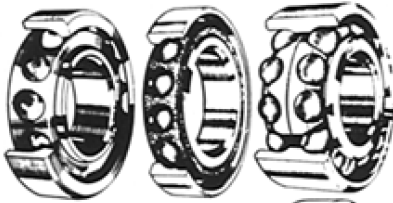

Single/double row angular contact ball bearings

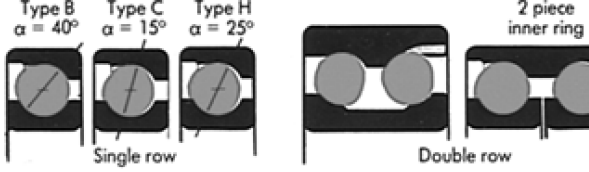

Single row SERIES	Double row SERIES
7000 C*	3200
7200 B, C*	3300
7300 B, C	
SERIES	
71900 C*	

***high precision bearings**



Double row self-aligning ball bearings

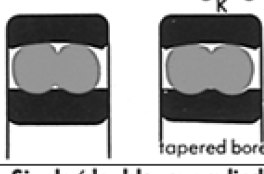

SERIES
1200 - 1300
2200 - 2300



Single/double row cylindrical roller bearings

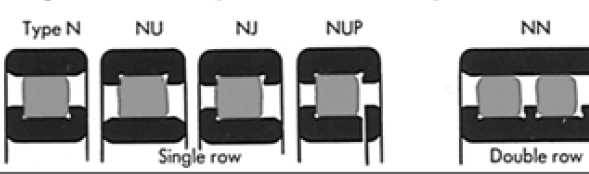

Single row SERIES	Double row SERIES
N, NU, NJ, NUP	NN, NNU
1000 - 200	3000
300 - 400	
2200 - 2300	



Tapered roller bearings

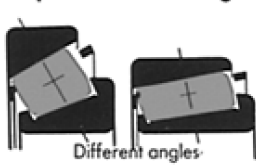

SERIES	
30200	32300
30300	32300 B
31300	33000
32000	33100
32200	33200
32200 B	



Single/double row spherical roller bearings

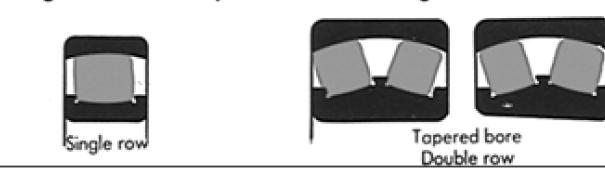

Single row SERIES	Double row SERIES
20200	21300
20300	23100
	22200
	23200
	22300
	23800
	23000
	23900



Thrust ball or roller bearings

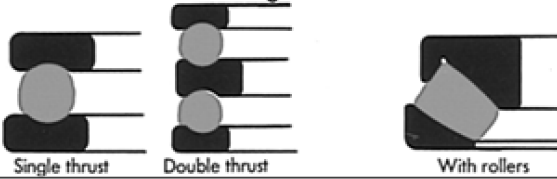

SERIES	Double thrust	With rollers
Single thrust		
51100	52200	29300
51200	52300	29400
51300		



Needle roller bearings

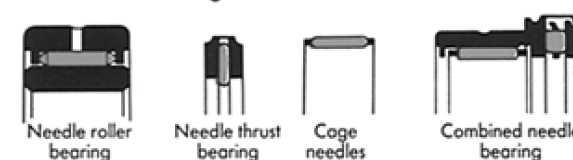

Needle roller bearings
Needle case assemblies
Cage needles
Needle thrust bearings
Combined needle bearings

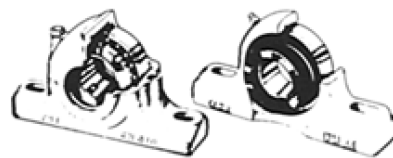

Plummer blocks

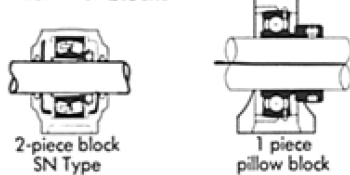

2-piece blocks
SN 500 - SN 600
series for self-aligning
ball or roller bearings.
Self-aligning pillow block
fitted with ball bearings having
spherical outside diameter.

AGRICULTURAL DRIVE SHAFT SPARES CHART

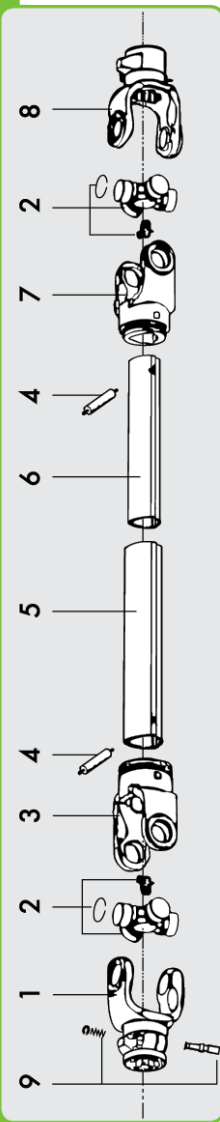

Series	1 Tractor Yoke	2 Universal Joint	3 Outer Tube Yoke Triangular	3 Outer Tube Yoke Lemon	4 Roll Pin	5 Outer Tubing Triangular	5 Outer Tubing Lemon	6 Inner Tubing Triangular	6 Inner Tubing Lemon	7 Inner Tube Yoke Triangular	8 Inner Tube Yoke Lemon	8 Pinch Bolt Yoke (Bore Size)	9 QR Pin Kit
1	6 Spline 1.05_07_PTO	22x54 1_41_PTO	54x22x32.4 1_06_PTO	54x22x39.1 1_04P_PTO	8x50 1_13_PTO	32.4x2.5 1_03_PTO	39.1x30x2.8 1_03IP_PTO	26.6x3.5 1_04_PTO	30.8x23.7x3.4 1_04IP_PTO	54x22x26.6 1_07_PTO	54x22x30.8 1_07IP_PTO	20 30 32	1082555
2	6 Spline 2.05_07_PTO	23.8x61.3 2_41_PTO	61.3x23.8x36.1 2_06_PTO	61.3x23.8x48 2_06IP_PTO	8x55 2_13_PTO	36.1x3.4 4_03_PTO	48x41.2x2.8 4_03IP_PTO	29x4 4_04_PTO	40.1x34.5x4 4_04IP_PTO	61.3x23.8x29 2_07_PTO	61.3x23.8x40.1 2_07IP_PTO	25 30 32	1082555
3	6 Spline 3.05_07_PTO	27x70 3_41_PTO	70x27x43.4 3_06_PTO	70x27x48 3_06IP_PTO	8x60 4_13_PTO	43.4x3.3 4_03_PTO	48x41x3 4_03IP_PTO	36.1x4.4 4_04_PTO	40.1x34.5x4 4_04IP_PTO	70x27x36.1 3_07_PTO	70x27x40.1 3_07IP_PTO	32 35 35	10825
4	6 Spline (Z6) 1/2 4.05_07_PTO 21 Spline (Z21) 1/2 4.05_08_PTO 6 Spline (Z6) 1/2 4.05_09_PTO 20 Spline (Z20) 1/2 4.05_10_PTO	27x74.6 4_41_PTO	74.6x27x43.4 4_06_PTO	74.6x27x48 4_06IP_PTO	8x60 4_13_PTO	43.4x3.3 4_03_PTO	48x41.2x2.8 4_03IP_PTO	36.1x4.4 4_04_PTO	40.1x34.5x4 4_04IP_PTO	74.6x27x36.1 4_07_PTO	74.6x27x40.1 4_07IP_PTO	25 32 38	10825
5	6 Spline 5.05_07_PTO	30.2x80 5_41_PTO	80x30.2x51.3 5_06_PTO	80x30.2x57.5 5_06IP_PTO	10x80 6_13_PTO	51.3x2.9 5_03_PTO	57.5x48x3.8 6_03IP_PTO	44.7x4 5_04_PTO	49x39.5x4.5 6_04IP_PTO	80x30.2x44.7 5_07_PTO	80x30.2x49 5_07IP_PTO	32 35	10825
6	6 Spline (Z6) 1/2 6.05_07_PTO 21 Spline (Z21) 1/2 6.05_08_PTO 6 Spline (Z6) 1/2 6.05_09_PTO 20 Spline (Z20) 1/2 6.05_10_PTO	30.2x92 6_41_PTO	92x30.2x53.6 6_06_PTO	92x30.2x57.5 6_06IP_PTO	10x80 6_13_PTO	53.6x3.8 6_03_PTO	57.5x48x3.8 6_03IP_PTO	44.7x4 6_04_PTO	49x39.5x4.5 6_04IP_PTO	92x30.2x44.7 6_07_PTO	92x30.2x49 6_07IP_PTO	30 32 38 45 50	10825

PLASTIC SHIELD CROSS JOINT

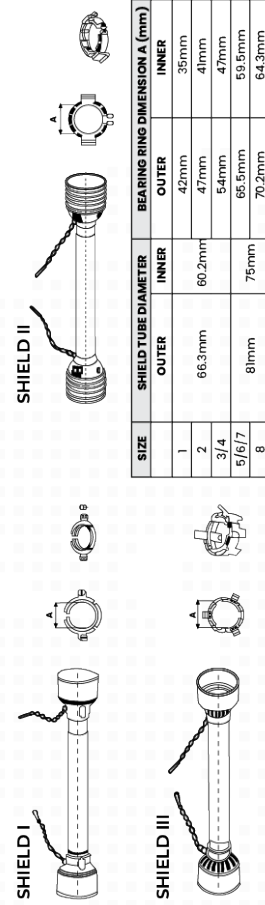

SIZE	SHIELD TUBE DIAMETER		BEARING RING DIMENSION A (mm)	
	OUTER	INNER	OUTER	INNER
1	66.3mm	60.2mm	42mm	35mm
2	66.3mm	60.2mm	47mm	41mm
3/4	81mm	75mm	54mm	47mm
5/6/7	81mm	75mm	66.5mm	59.5mm
8	81mm	75mm	70.2mm	64.3mm

WIDE ANGLE JOINT

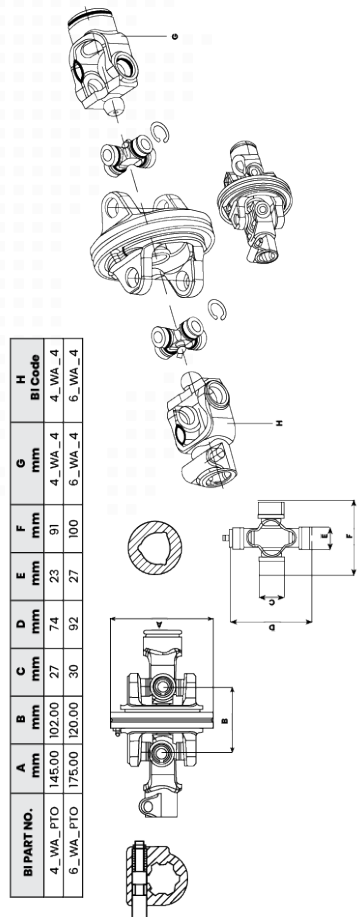

BI PART NO.	A mm	B mm	C mm	D mm	E mm	F mm	G mm	H mm	BI Code
4_WA_PTO	145.00	102.00	27	74	23	91	4_WA_4	4_WA_4	4_WA_4
6_WA_PTO	175.00	120.00	30	92	27	100	6_WA_4	6_WA_4	6_WA_4

AGRICULTURAL PRODUCTS

Agricultural Hub Units

Product	Use	Available Series / Type
Angular Contact Hub Unit	Agricultural wheel and implement hub support	Right Hand Thread (BAA0005_R), Left Hand Thread (BAA0005_L)
Closer Wheel Adaptor Shaft	Closer wheel shaft support systems	CW_SHAFT_L / CW_SHAFT_R
Gauge Wheel Adaptor Shaft	Gauge wheel mounting and rotation	GW_SHAFT_L / GW_SHAFT_R

Agricultural Chains & Conveyor Components

Product	Use	Available Series / Type
A2050 Double Pitch Chain	Agricultural conveying and drive systems	A2050
A557 Chain with K39 Slotted Attachments	Feeders and conveyor applications	A557
38.4V Chain with SD Attachments	Agricultural transfer systems	38.4V
AL667XH Pintel Chain	Heavy-duty agricultural conveying	AL667XH
C2040 Hollow Pin Chain	Conveyor and transfer drives	C2040
C2052 Large Roller Hollow Pin Chain	Agricultural machinery chain drives	C2052
CA2062H Heavy Duty Chain	Heavy agricultural conveyor applications	CA2062H
CA2062X24 Pilot Bore Sprocket	Agricultural sprocket drive systems	CA2062X24
CA550 Chain with K25 Attachments	Conveyors and paddles	CA550
CA550 Paddle Attachment	Paddle conveying systems	CA550

Agricultural Bearings

Product	Use	Available Series / Type
Disc Harrow Ball Bearing	Disc harrow support and rotation	W208_PP6_C, W208_PP5_C, W208_PP5
Radial Insert Ball Bearing	Agricultural shaft support	207_KRRB12_C, 207_KRRB9_C
Deep Groove Ball Bearing	General agricultural machinery support	88506
Double Row Angular Contact Bearings	High-load agricultural applications	30BG05S2G_2DS_C, 30BG05S5G_2DS_C
Disc Harrow Bearing Unit	Lubricatable bearing unit for harrows	4509_B, 613233_H_C

Table continues...

AGRICULTURAL PRODUCTS continued

PTO (Power Take-Off) Components

Product	Use	Available Series / Type
PTO Steel Tubing	PTO shaft transmission	Series 6 Triangular / Lemon Steel Tubing
PTO Quick Release Yoke	PTO connection systems	Series 6
PTO Bolted Yoke	PTO driveline connection	Series 6
PTO Clamp Yoke	PTO shaft clamping	Series 6
PTO Roll Pin	PTO shaft locking	Series 6
PTO Roll Pin	PTO shaft locking	Series 6
PTO Universal Cross Journal	PTO joint articulation	Series 6
PTO Wide Angle Cross Journal	Wide-angle PTO applications	Series 6
PTO Friction Clutch	Overload protection	Series 6
PTO Overrun Clutch Yoke	Prevent reverse drive rotation	Series 6
PTO Shear Bolt Yoke	Mechanical overload protection	Series 6
PTO Wide Angle Assembly	Wide-angle PTO drive systems	Series 6
PTO Guard	PTO shaft safety guarding	Series 6
Complete PTO Shaft Assemblies	Agricultural implement power transmission	Series 4 & Series 6

Agricultural Gearboxes & Sprockets

Product	Use	Available Series / Type
Slasher Gearbox	Slasher and mower drive systems	RC61 PTO
Plate Wheel Sprocket	Feeder house drive systems	CA557X13T_PW
Drive Sprocket Assemblies	Agricultural chain drive systems	JD_ANI02448X9T JD_H85252



ELECTRIC MOTORS & POWER TRANSMISSION

EXPLODED VIEW OF THE D MOTOR

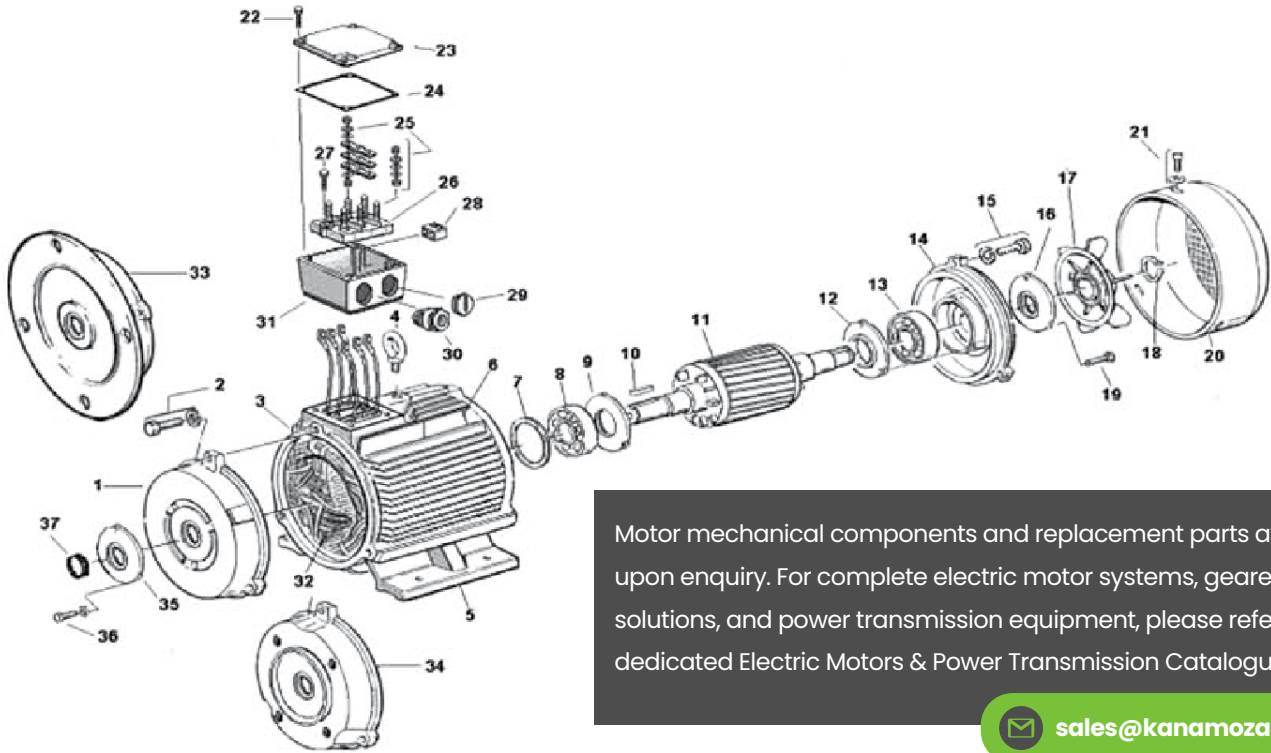

Motor mechanical components and replacement parts available upon enquiry. For complete electric motor systems, geared drive solutions, and power transmission equipment, please refer to the dedicated Electric Motors & Power Transmission Catalogue.

 sales@kanamoza.co.za

Description of the parts:

- | | |
|---|--|
| 1. Drive end shield IM B3 | 19. Non drive end outer bearing cap bolts |
| 2. Drive end shield bolts (fixing) | 20. Fan cowl |
| 3. Stator - frame | 21. Fan cowl screw |
| 4. Eye bolt | 22. Terminal box cover screw |
| 5. Feet - IM B3 | 23. Terminal box cover |
| 6. Name plate | 24. Gasket |
| 7. Spring washer | 25. Connection fixation nuts & bridges |
| 8. Drive end bearing | 26. Terminal board |
| 9. Drive end inner bearing cap(D180 - 355) | 27. Terminal board holder bolts |
| 10. Key(full moon) | 28. Terminal block PTC |
| 11. Rotor | 29. Blindstop |
| 12. Non drive end inner bearing cap(D180 - 355) | 30. Cable gland |
| 13. Non drive end bearing | 31. Terminal box house |
| 14. Non drive end shield | 32. Windings |
| 15. Non drive end shield bolts | 33. Flange - IM B5 |
| 16. Non drive end outer bearing cap(D180 - 355) | 34. Flange - IM B14 (small or large) |
| 17. Fan | 35. Drive end outer bearing cap (D180-355) |
| 18. Cir-clip | 36. Drive end outer bearing cap bolts |
| | 37. V-ring |

GEARBOXES & GEARED UNITS

Industrial gearbox solutions designed for torque control, speed reduction, and efficient mechanical transmission.

APPLICATIONS

- Conveyors
- mixers,
- crushers,
- pumps,
- heavy industrial machinery.

COUPLINGS

Industrial coupling systems designed to connect rotating shafts while accommodating misalignment and reducing vibration.

APPLICATIONS

- Conveyors
- mixers,
- crushers,
- pumps,
- heavy industrial machinery.

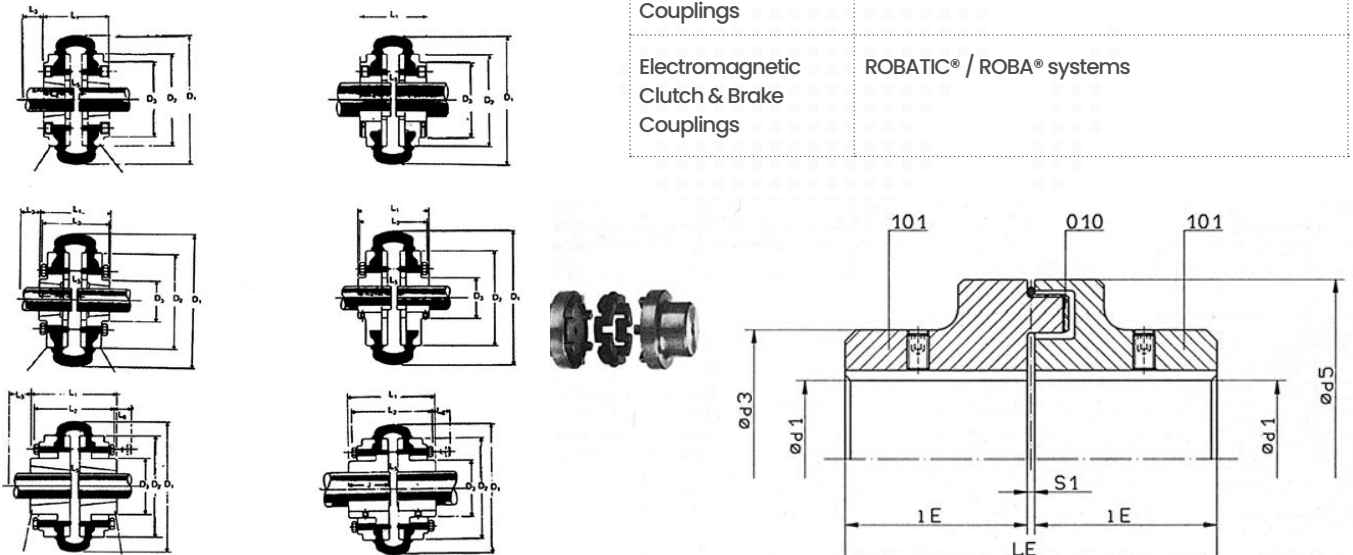

AVAILABLE TYPES

- **Rapid Demulse 220**
- **Refrigeration Compressor Oil**
- **Foodlube Hi-Torque 150**
- **Foodlube Hi-Torque 220**
- **Foodlube Hi-Torque 320**
- **Foodlube Hi-Torque 460**
- **Vac Pump Oil**

***Available in 5L, 20L and 200L*

AVAILABLE TYPES

Coupling Type	Reference
Flex Couplings	Main flex coupling range
Normex Couplings	Elastic transitional ring coupling
Lamidisc® Couplings	Disc coupling system
Fluid Couplings	Fluid transmission coupling systems
Tschan Flexible Couplings	Used with fluid coupling assemblies
MT Couplings	Basic design coupling range
Torque Limiter Couplings	EAS® overload protection systems
Electromagnetic Clutch & Brake Couplings	ROBATIC® / ROBA® systems

BELTS & PULLEYS

Reliable belt and pulley systems designed for efficient mechanical power transmission, reduced slippage, and dependable industrial drive performance.

Consult with Kanamoza for industrial belt, pulley, conveyor chain, and drive transmission solutions tailored to operational requirements, equipment compatibility, and application performance.

Supply available across various industrial configurations suitable for manufacturing, conveying systems, agricultural machinery, mining operations, and heavy-duty mechanical power transmission environments sourced from trusted industrial suppliers.

APPLICATIONS

- Compressors,
- conveyor systems,
- pumps,
- agricultural equipment,
- industrial drive systems.

AVAILABLE TYPES

British Series

British standard conveyor chains designed for reliable power transmission and industrial conveying.

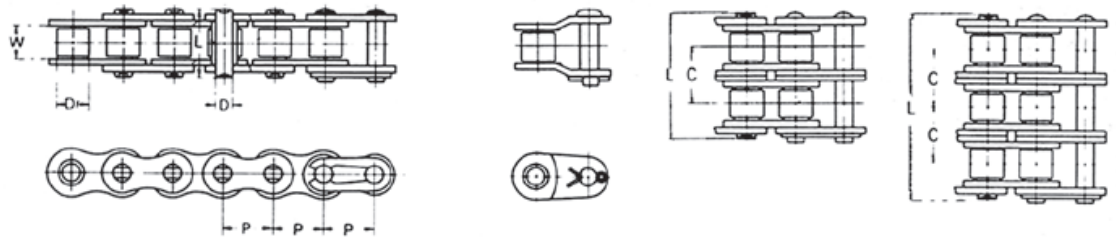

American Series

American standard conveyor chains engineered for heavy-duty industrial drive applications.

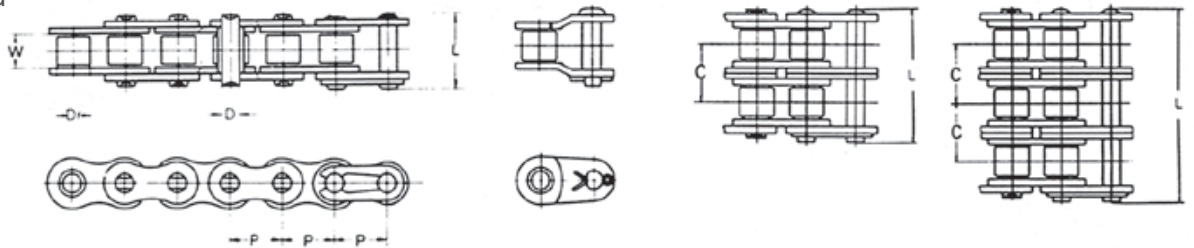

Pilot Bore

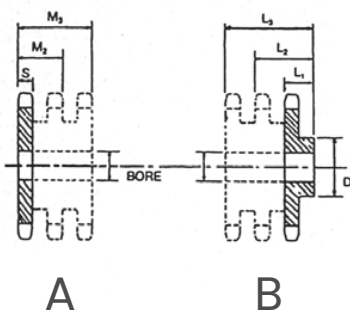

We offer Type A and Type B Sprockets.

Available in Type A and Type B sprocket configurations suitable for various conveyor, chain drive, and industrial transmission applications. Pilot bore sprockets supplied for custom machining, shaft sizing, and application-specific industrial drive requirements.

CHAINS & SPROCKETS

Heavy-duty chain and sprocket systems manufactured for high-performance industrial power transmission.

APPLICATIONS

- Material handling systems,
- conveyors,
- mining equipment,
- industrial machinery.

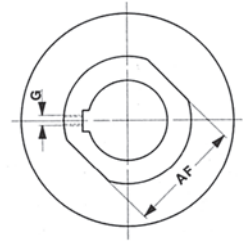
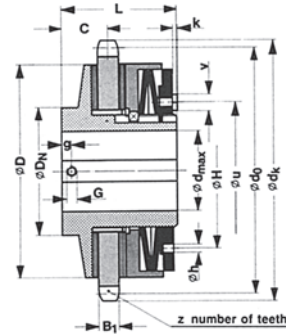

ROBA®-sproc is a compact overload protection chain plate wheel with integrated slip hub, designed for reliable roller chain drives. Built for high safety, efficient performance and cost-effective industrial power transmission solutions.

AVAILABLE TYPES

Taper-Brush Sprockets - British Standard Series

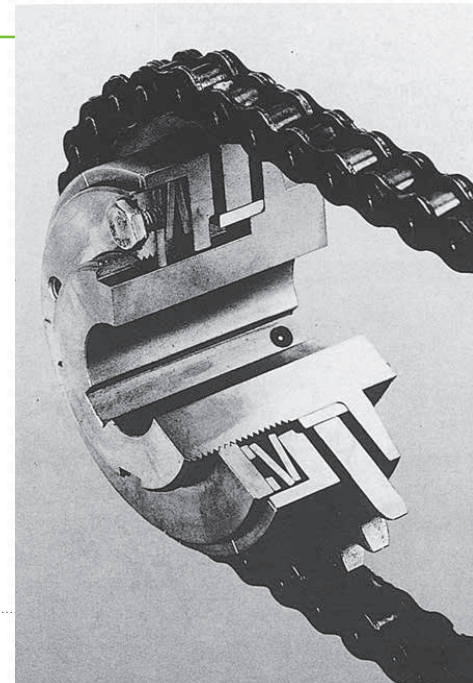
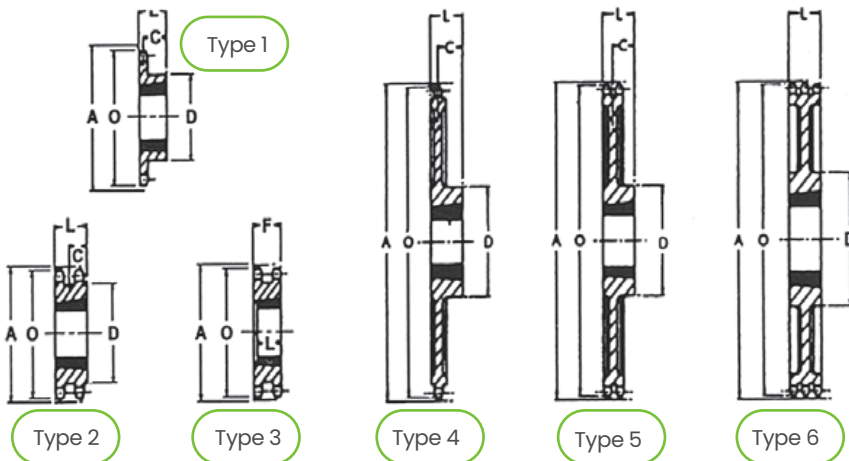

Roller Chain Sprockets

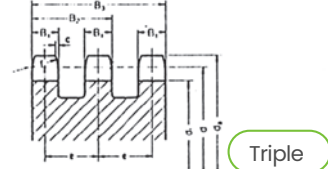
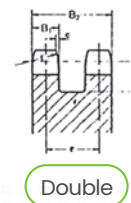
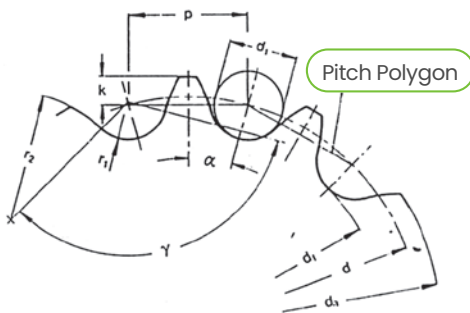

2 x Single or 2 x Double

Leaf Chains

- American Standard, Heavy Series
- Industry Standard
- European Standard, Light Series

Conveyor Chains

- SOLID PIN SERIES
- HOLLOW PIN SERIES
- DEEP LINK SERIES

Scraper Chains

- Code 10160-R
- Code 14218
- Code 14226
- Code 26040

Drop Forged Scraper Chains

- See Table on next page.

Drop Forged Scraper Chains

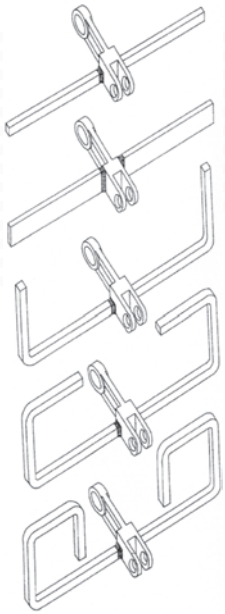

SCRAPER TYPE: Square or rectangular
TYPE OF CONVEYOR: Horizontal or inclined till 100°

SCRAPER TYPE: Plate
TYPE OF CONVEYOR: Horizontal or inclined till 100° for dusty material

SCRAPER TYPE: "U" folded
TYPE OF CONVEYOR: Inclined till 250°

SCRAPER TYPE: "C" folded
TYPE OF CONVEYOR: Inclined from 250° till 90° for dusty material.

SCRAPER TYPE: Double O' folded
TYPE OF CONVEYOR: Inclined from 250° till 90°.

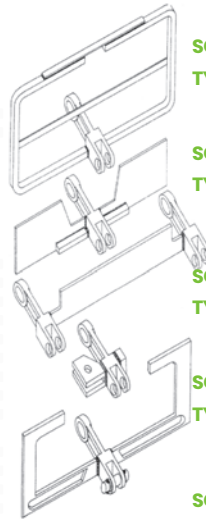

SCRAPER TYPE: "C" folded
TYPE OF CONVEYOR: Horizontal or inclined from 20° to 90°

SCRAPER TYPE: K reinforced
TYPE OF CONVEYOR: Horizontal or inclined till 30° for dusty material

SCRAPER TYPE: Special attachments
TYPE OF CONVEYOR: For special use

SCRAPER TYPE: "C" folded
TYPE OF CONVEYOR: Inclined from 250° till 90° for dusty material

SCRAPER TYPE: Double O' folded
TYPE OF CONVEYOR: Inclined till 90° for big load

Provide equipment specifications, operating conditions, or component requirements to receive suitable industrial solutions and available configurations.

sales@kanamoza.co.za

WHY CHOOSE KANAMOZA INDUSTRIAL SUPPLIERS

FOR **MECHANICAL COMPONENTS** PROCUREMENT

We help businesses across industries source high-quality mechanical components efficiently, reliably and cost-effectively.

Your success is our priority.



QUALITY YOU CAN TRUST

We supply only high-quality mechanical components from reputable brands and manufacturers.



WIDE PRODUCT RANGE

From bearings, seals, fasteners and power transmission to hydraulics, pneumatics and more.



RELIABLE PARTNER

We build long-term relationships through honesty, consistency and excellent service.



COMPETITIVE PRICING

We help you reduce downtime and overall costs with quality parts at competitive prices.



FAST & EFFICIENT DELIVERY

With a strong supplier network and streamlined processes, we get your parts to you—fast.



EXPERT SUPPORT

Our team of industry experts is ready to assist you in finding the right solutions.



KANAMOZA PTY LTD
Industrial Suppliers



www.kanamoza.co.za



sales@kanamoza.co.za



062 754 0975



Glenvist, Johannesburg, ZA